

OLYMPUS[®]

Research Stereo Microscope System

SZX16/SZX10

For Life Science Applications

Meet the Challenge of Life Science Imaging

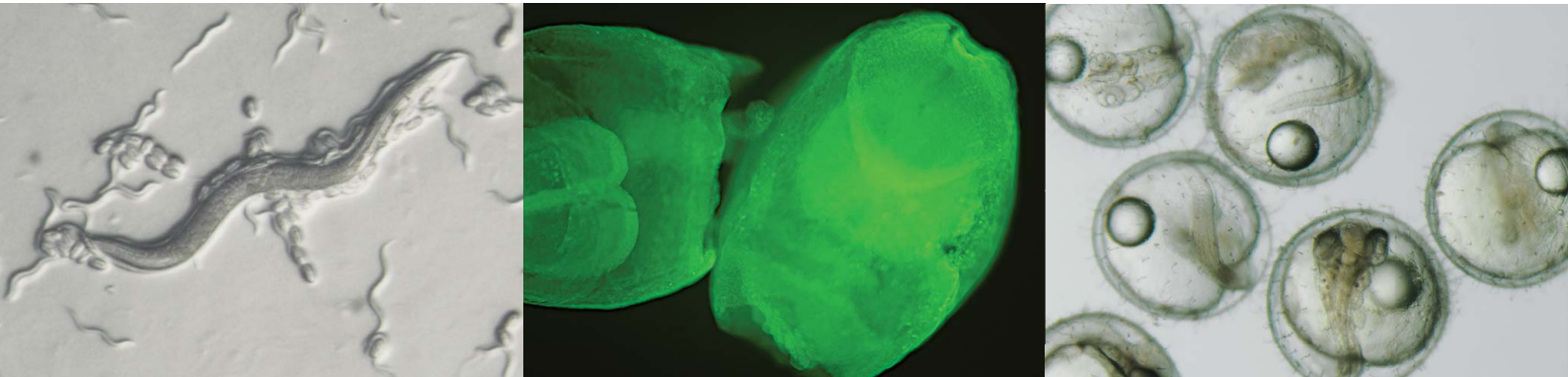

A New Dimension in Stereo Microscopy

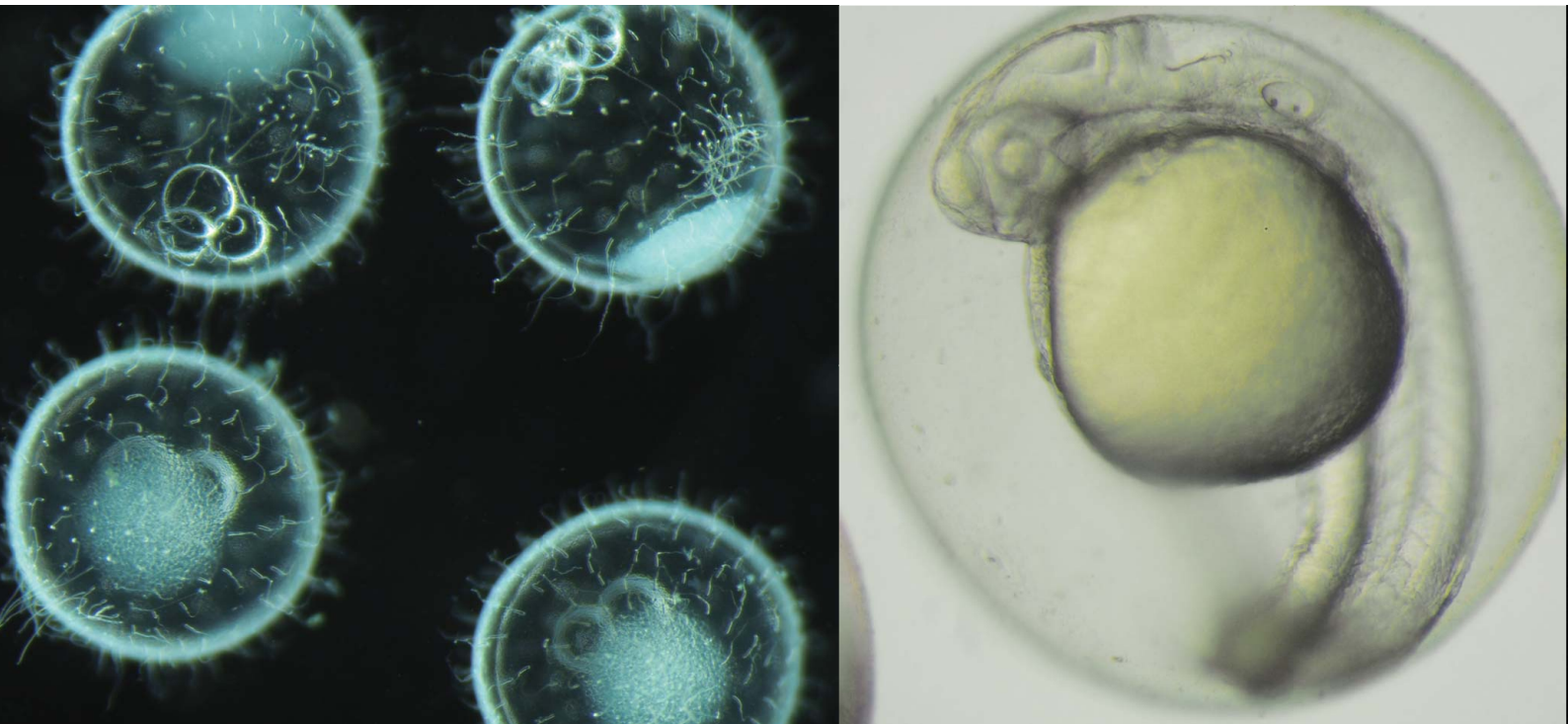

Olympus SZX2 series stereo microscopes are the suitable solution for leading-edge microscopy applications, offering an exceptionally wide zoom ratio and high numerical aperture (NA). Excellent image clarity and a flexible optical system make the SZX2 series easy to use, while their advanced optics, improved functionality, and ergonomic design deliver an outstanding user experience.

Modern life science laboratories require the most effective imaging tools to observe a vast quantity of live specimens. The SZX2 stereo microscope series is designed to meet these needs and is refined to the highest levels of quality and performance. The combination of a high NA and a multi-wavelength, astigmatism-free design yields high-resolution images with an increased depth of field. Furthermore, the quad position LED transmitted light illumination base enables you to easily switch observation method and contrast level by changing cartridges. The SZX2 microscope is redesigned with improved ergonomics that reduce operator fatigue and enable comfortable observation over a long period of time.



SZX16

■ P3–P8

A New Dimension in Image Clarity

Images are always sharp due to the high NA and multi-wavelength, astigmatism-free design that reduces aberration. From low to high magnification, you can achieve excellent bright and fluorescence observation.

■ P9–P10

Comfortable to Use

The long working distance (W.D.), high NA, and illuminated base accommodate a variety of sample types for an efficient workflow.

■ P11–P12

Flexible Transmitted Illumination

The LED illumination base enables the user to choose cartridges and to switch observation method and contrast.

■ P13–P14

Digital Imaging

From brightfield to fluorescence observation, users can acquire high-resolution images of various types of specimens.

■ P15–P16

Customizable to Suit Your Needs

Accessories for optimizing optical performance and operability include a variety of illumination bases, light guides, and stage plates.

SDF Objectives Provide Suitable Specimen Viewing from Large Field Overviews to Microstructures

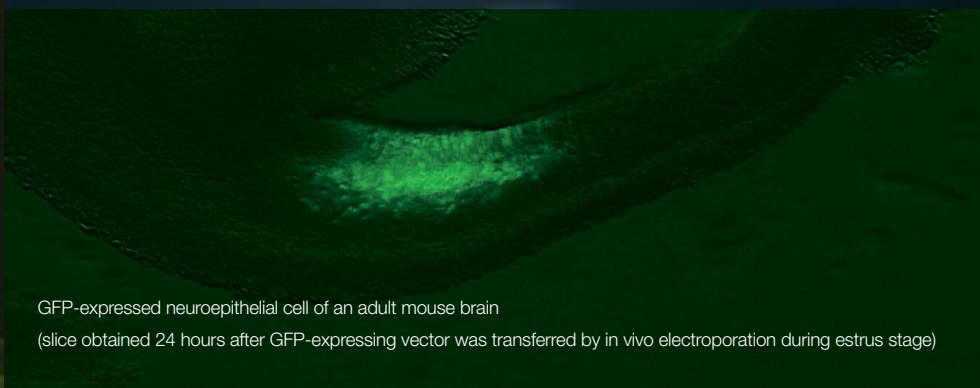
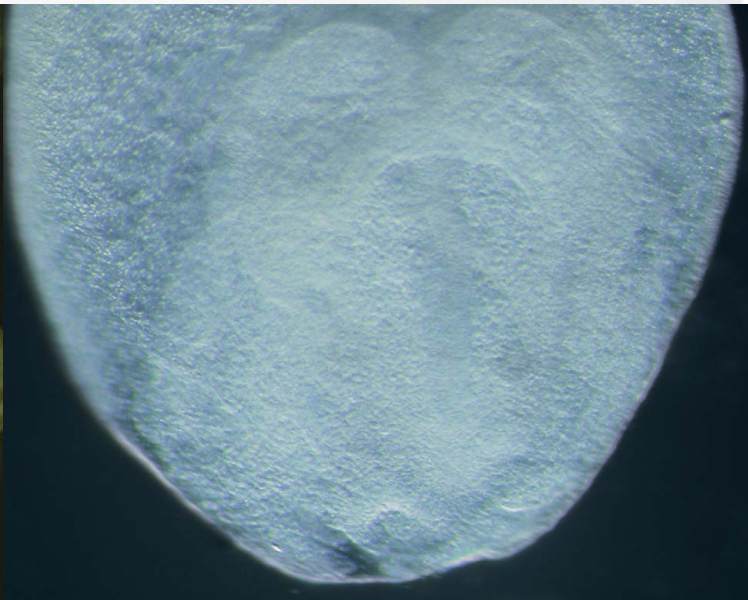
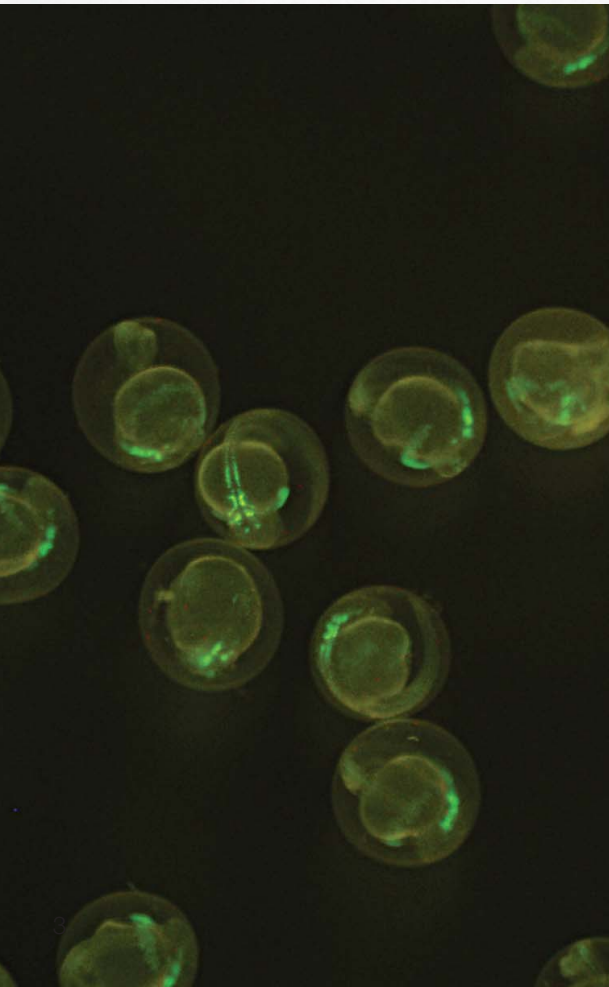

GFP-expressed neuroepithelial cell of an adult mouse brain
(slice obtained 24 hours after GFP-expressing vector was transferred by in vivo electroporation during estrus stage)

Wide 16.4:1 Zoom Ratio

The SZX16 offers good optical performance for nearly any application. Olympus SDF objective lenses have a high numerical aperture (NA), providing remarkable detail and clarity when viewing microstructures. With an extra-wide zoom range of 7.0X–115X, this all-in-one microscope answers a range of needs from low-magnification imaging to detailed, high-magnification observations. These features enable the user to view live specimens with low contrast and observe microstructures.

High NA

The SZX16 has an outstanding NA rating with 2X objective lenses. The optical performance is 30% better than previous Olympus stereo microscopes.



Previous Olympus stereo microscope

SZX16 (with SDFPLAPO2XPFC)

Six SDF Objectives for Various Uses

The SZX16 PLAN APO objective series meets many imaging needs from long working distance objectives for observing large specimens to high-magnification objectives with a high NA for observing microstructures.

Model	W.D. (mm)	Magnification*
SDFPLFL0.3X	141	2.1X–34.5X
SDFPLAPO0.5XPF	70.5	3.5X–57.5X
SDFPLAPO0.8X	81	5.6X–92X
SDFPLAPO1XPF	60	7X–115X
SDFPLAPO1.6XPF	30	11.2X–184X
SDFPLAPO2XPFC	20	14X–230X

*Using WHN10X-H



SDF Objective Lens Series

Wide-Angle Zoom Action for Versatile Operation

The SZX16 boasts a zoom range of 7.0X–115X*. From sample verification and selection at low magnification to microstructure verification at high magnification, users can seamlessly image a variety of specimens.

* When using the SDFPLAPO 1X and WHN10X-H

Two Objectives Combine with a Revolving Nosepiece for 3.5X – 230X Zoom

The Olympus parfocal series consists of 0.5X, 1X, 1.6X, and 2X objectives. Two parfocal objectives can be attached to the microscope's revolving nosepiece, enabling users to easily switch between lenses for smooth zooming between 3.5X and 230X (using WHN10X-H).



Sharp Images that Enhance Your Research

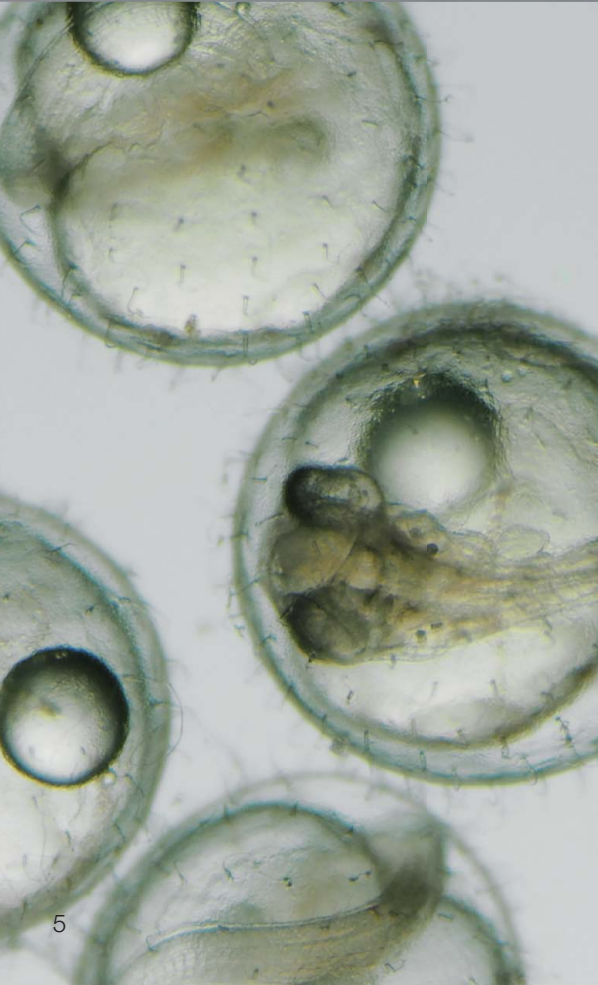
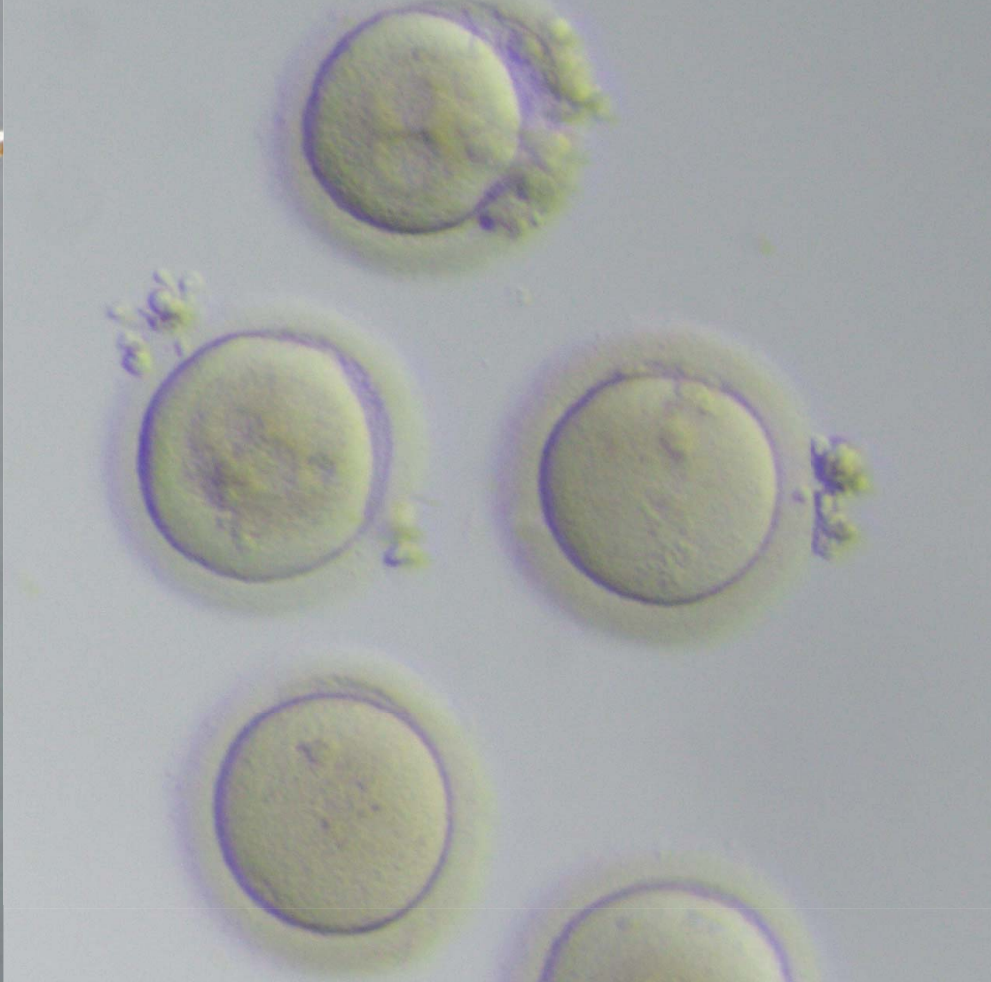

Setting the Standard in Image Clarity

The microscope's new multi-wavelength, astigmatism-free design effectively eliminates image-deforming aberrations, enabling remarkably sharp 3D imaging and enhanced specimen manipulation. With an apochromatic lens system that effectively reduces chromatic aberration, the latest proprietary SZX16 optical system provides vivid 3D observation images of various specimens.

Sharp, Detailed Observation of Specimens

SDF objective lenses reduce astigmatism. This effectively eliminates image deforming in the pre- and post-focal planes for a deeper depth of field. These design features enable stress-free use of forceps in the field of view during live sample selection and acquisition. When these objectives are combined with the transmitted light illumination base, users can observe low-contrast, transparent specimens. This reduces oversights for specimen selection, dissection, and manipulation.

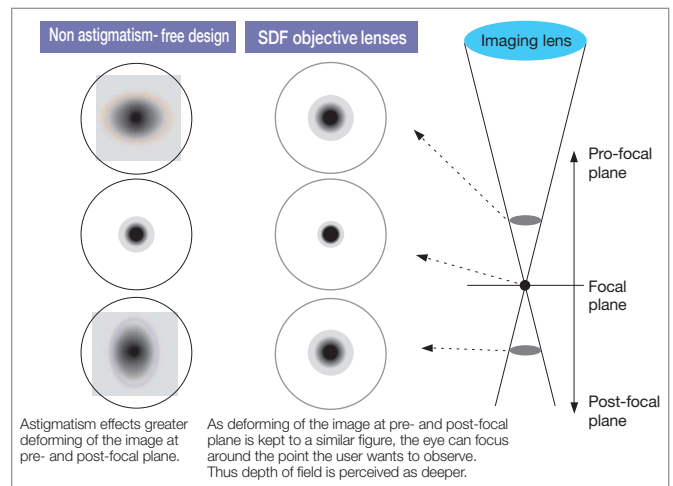

Depth of field seen in focal plane will vary according to individual differences in users' vision.

Integrated Apochromatic System

The apochromatic system—integrated into the observation tubes, zoom body, and objectives—eliminates chromatic aberration throughout the zoom range and helps acquire high image quality without chromatic blur.



Optical Performance with Less Fatigue

A 360° view of balanced images is made possible by accommodating vertical and horizontal parameters. Discomfort in the eyes and body, as well as stress from long periods of observation or operation, is effectively reduced.

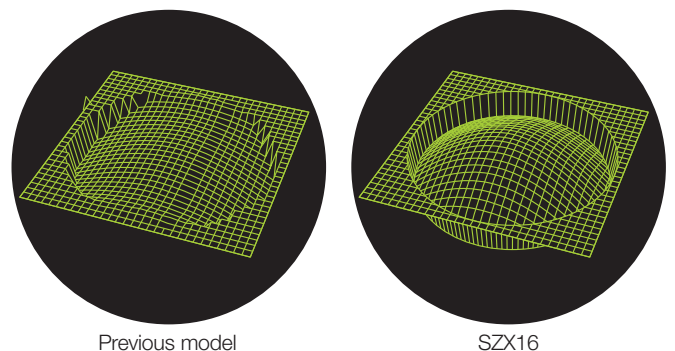

SZX16: Optics Easily Accommodate Thick Specimens

The ability to clearly perceive the depth and dimensions of thick specimens, like eggs or embryos, is important in many applications. The SZX16 delivers clear 3D images from the surface and interior of live specimens for applications such as dissection.

Efficient Observation from Low to High Magnification,
Even in Fluorescence Imaging

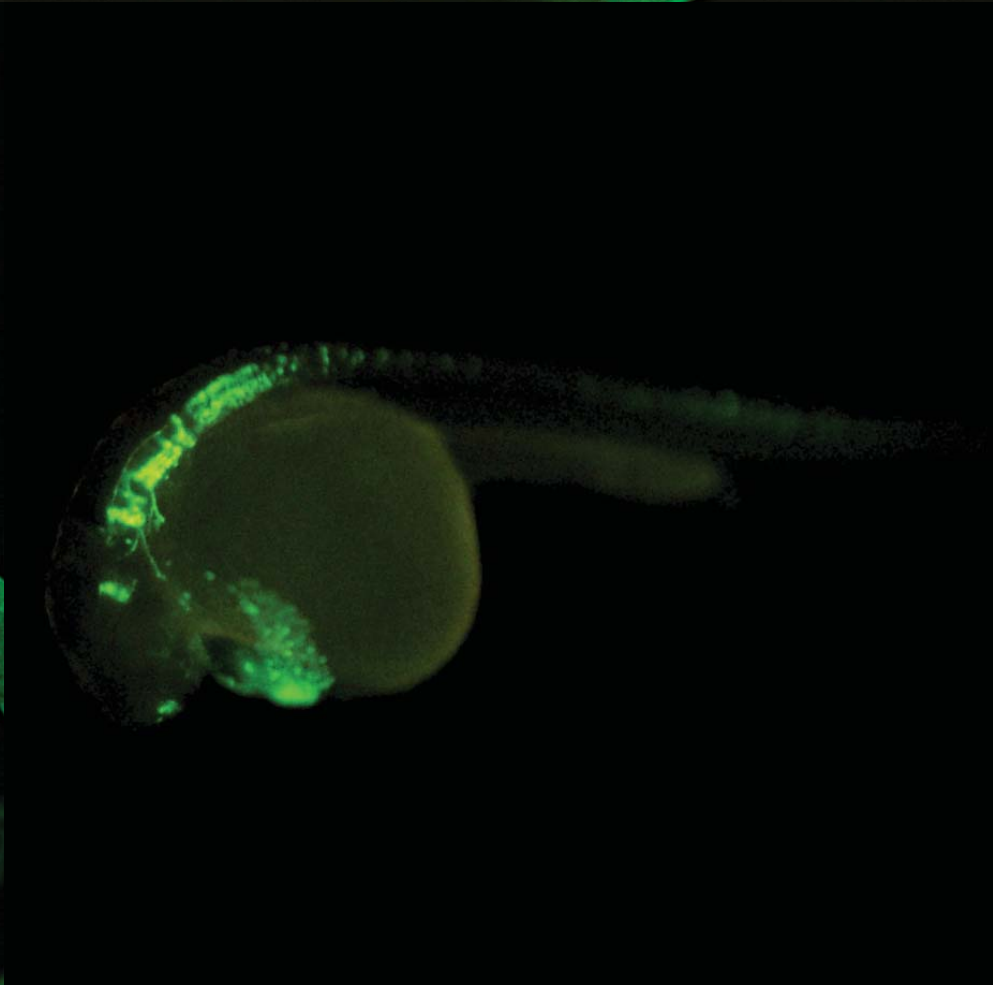
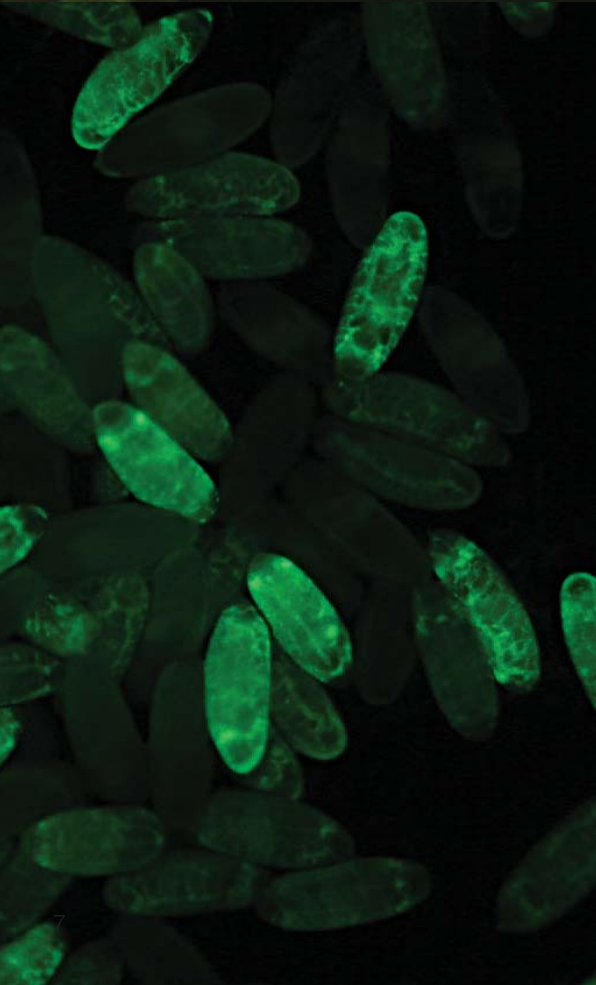
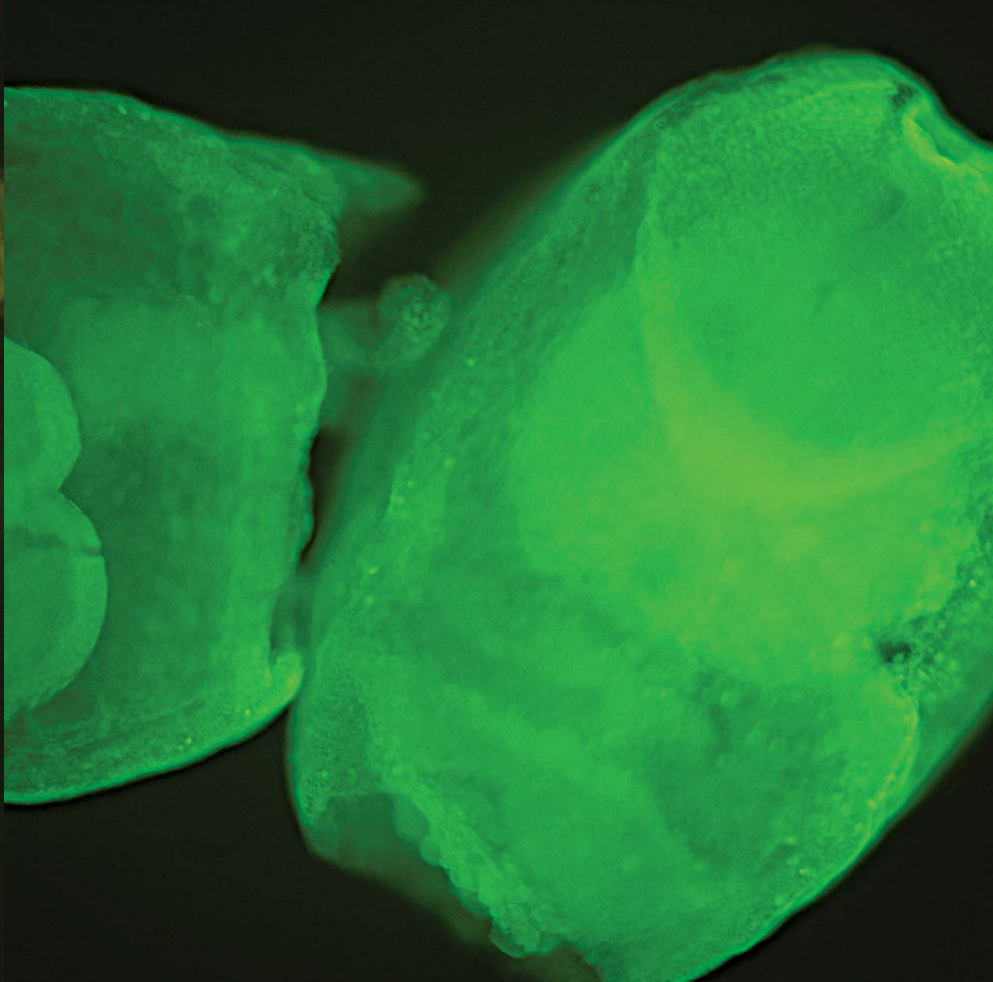
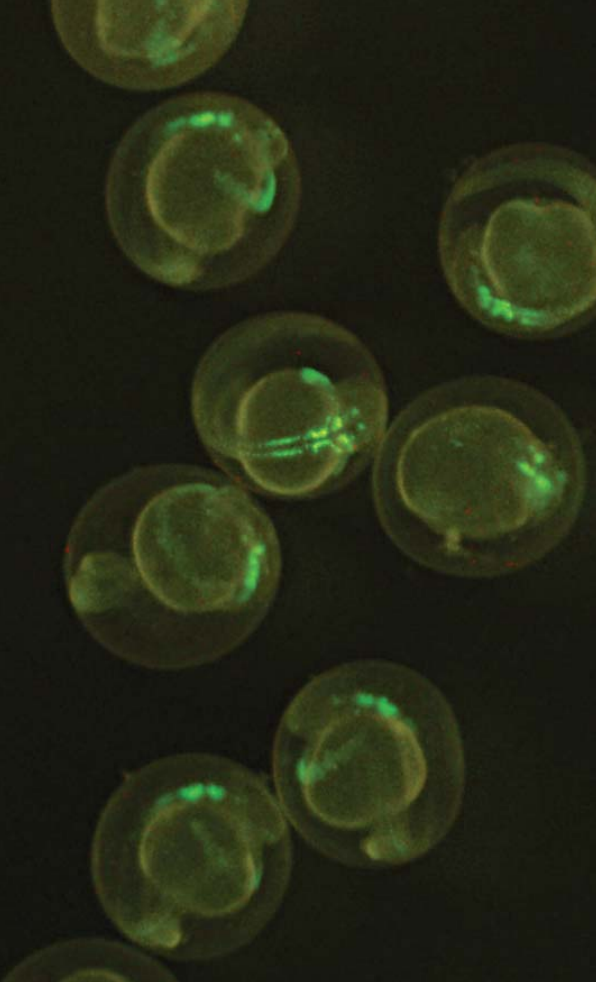

SDF Objectives Significantly Improve Signal Intensity and Support Bright Fluorescence Observation

Bright fluorescence observation is important in biological and medical research. Weak fluorescence is a common problem when observing specimens at low magnification under a stereo microscope. The SZX16 microscope enables even and bright fluorescence observation from low to high magnifications.

High NA for Bright Fluorescence Observation

The SDF lenses' high NA greatly improves fluorescence sensitivity. Furthermore, the newly designed near-vertical reflected light illuminator's excitation light paths are independent from the observation paths, enabling substantially improved excitation light efficiency. These features provide far brighter fluorescence observation than conventional stereo microscopes at all magnifications. Transmitted light observation to verify the specimen's outline is possible even under reflected light fluorescence observation.

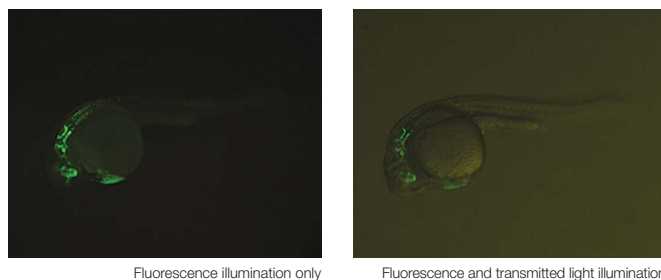

Fluorescence illumination only

Fluorescence and transmitted light illumination

Even and Seamless Fluorescence Observation from Low to High Magnification

The near-vertical reflected light illuminator works in conjunction with the zoom function to provide even illumination over the entire magnification range. Motorized focus and zoom units make for easy viewing using a hand switch.



SZX16 reflected light fluorescence illumination stand

Five-Position Turret with Nine-Filter Selection

Nine filter units, ranging from UV excitation to red fluorescent protein (RFP), enable imaging using various fluorescent dyes and proteins. Olympus high-quality (HQ) filters have an edge steepness and high transmission that efficiently detect the fluorescent light to enhance and capture brighter fluorescent images in precise detail.

Filter unit	Model	Remarks
For UV excitation	SZX2-FUV	Ex330-385/Em420-
For BV excitation	SZX2-FBV	Ex400-440/Em475-
High performance for CFP	SZX2-FCFPHQ	Ex425-445/Em460-510
For GFP	SZX2-FGFP	Ex460-490/Em510-
For GFP separation	SZX2-FGFPA	Ex460-495/Em510-550
High performance for GFP	SZX2-FGFPHQ	Ex460-480/Em495-540
High performance for YFP	SZX2-FYFPHQ	Ex490-500/Em510-560
For RFP 1	SZX2-FRFP1	Ex530-550/Em575-
For RFP 2	SZX2-FRFP2	Ex540-580/Em610-



SZX16 Fluorescent filter unit

Ergonomically Designed and Optimized for User Comfort



Configure the Microscope to Match Your Needs

The SZX2 handles a variety of specimens and operations—from large specimens like mice to small ones like Zebrafish, nematodes, *C. elegans*, or drosophila eggs—with an effective combination of high numerical aperture and wide working space. Moreover, the transmitted light illumination base is thin (only 41.5 mm, 1.6 in.) to provide a wide working space and enable multiple users to work comfortably.

Wide Working Space and High NA

W.D. 60 mm and NA 0.15 from the 1X objective

The 1X objective has a 60 mm working distance that gives the user room to move and an NA of 0.15 that meets the needs of advanced research. Also available are 0.8X objectives that have a working distance of 81 mm, and provide not only a larger working space between objective lenses and sample but also a total magnification of 5.6X–92X (using the WHN10X-H).



Easy-to-access 2X objectives and correction collar

The intelligent design enables users to easily access objectives and delivers a high NA of 0.3 for easy specimen selection. An additional correction collar can adjust image quality independently of the specimen—a first in stereo microscopes.



Ergonomically Designed, User-Friendly Base

Offering a wide working space in which users can place several Petri dishes, these illumination bases have an ergonomic, beveled design so users can work comfortably and naturally.

Observation Tube with Optimized Convergence Angle Relieves Eyestrain

Working with an ophthalmologist, Olympus investigated and confirmed a correlation between stereo microscope optical systems and eyestrain. Specifically, the angle between right and left lines of vision (convergence angle) directly impacts eyestrain. The SZX2 series has an optimized convergence angle designed to enable users to make observations from a natural position that minimizes eye fatigue. This solution effectively eliminates eyestrain during long periods of observation.



Observation tube with convergence angle

Ergonomic Accessories Enable Users to Optimize the Microscope for Their Comfort

To improve the ergonomics of our stereo microscopes, Olympus introduced a long tilting trinocular tube (SZX2-LTTR). This trinocular can be adjusted from 5 to 45 degrees. In addition, the eyepoint adjuster (SZX2-EEPA) can raise and lower the eyepoint within a 120 mm range. Combining these units enable users to reduce stress and fatigue over longer periods of time by working in a natural posture.



Tilting trinocular tube

Choose the Right Contrast and Observation Method for Your Research

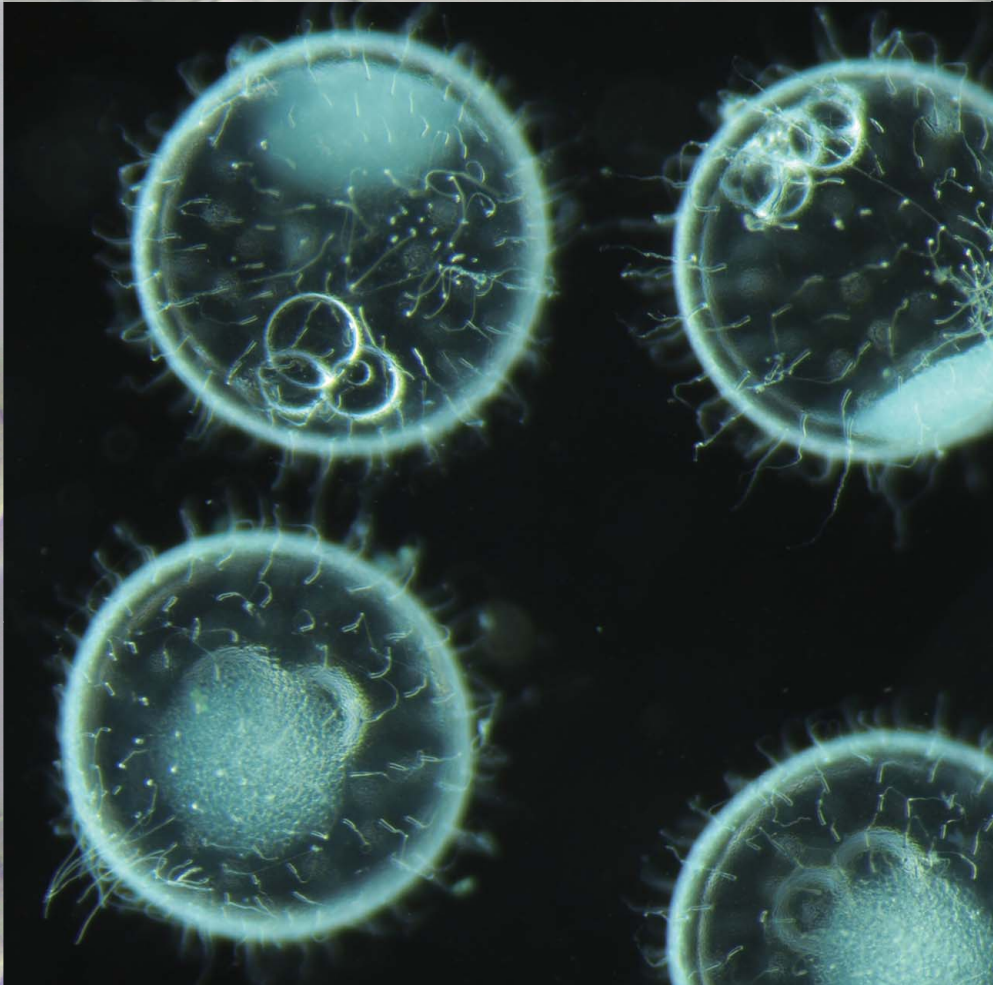
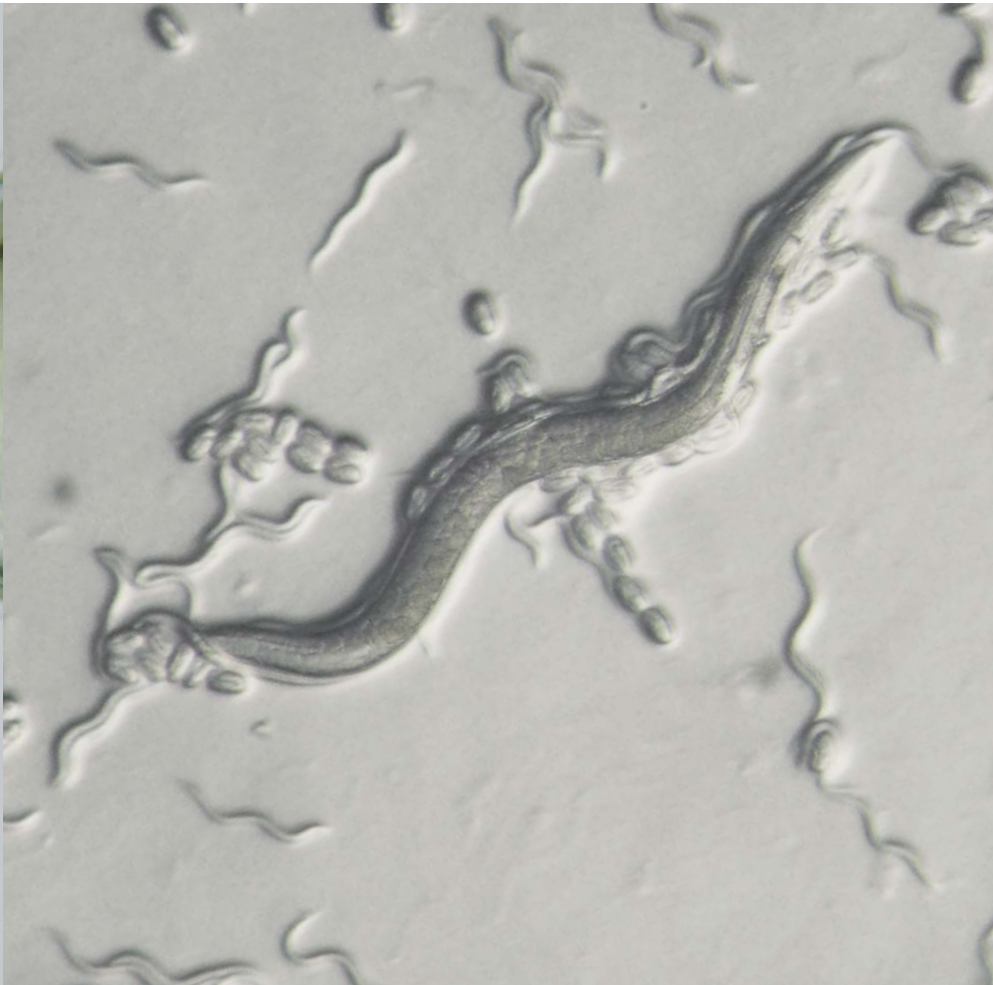
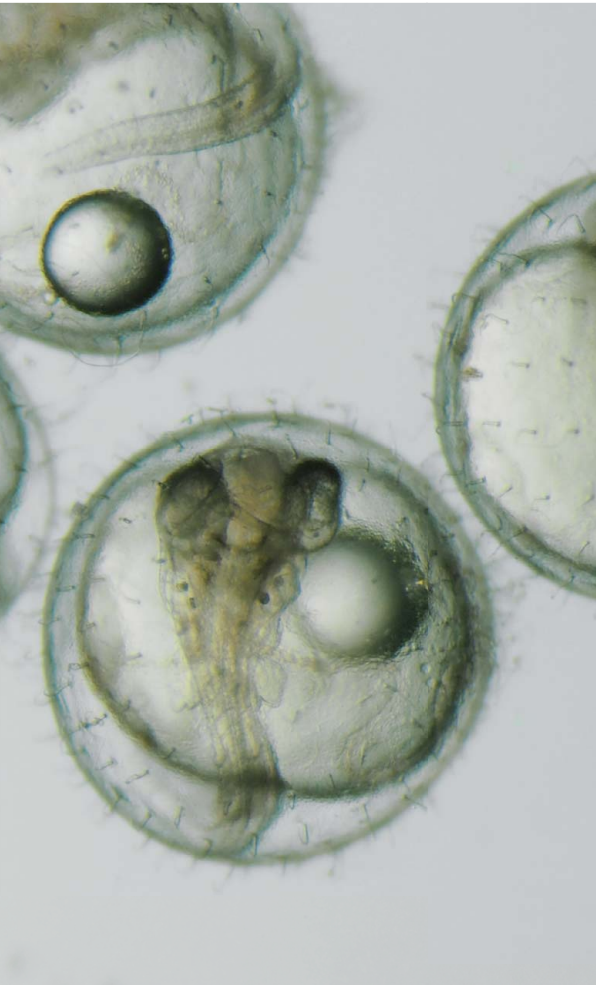

Choice of Suitable Contrast and Observation Method SZX2-ILLTQ/SZX2-ILLTS

With a slim 41.5 mm design that is approximately half the thickness of previous halogen transmitted light illumination bases, our LED transmitted light illumination bases have a lower height to enable a low eyepoint and easy access to base-mounted samples during observation and operation. The LED illumination base SZX2-ILLTQ with quad position turret enables the user to choose cartridges and to switch from brightfield (standard/high/low), oblique (standard/high/low), darkfield, polarized illumination, and shutter with a simple turn. A one position LED illumination base is also an option (SZX2-ILLTS). This makes the SZX2 series a flexible all-in-one microscope for various samples and observation tasks. Another advantage of LED illumination is a cooler base surface, which is suitable for long duration manipulation of live specimens. Power consumption is lower than a conventional 30 W halogen light source. A life cycle of over 60,000 hours significantly reduces operation costs.



Slim LED transmitted light Illumination base



	Product	Observation Methods and Contrasts
①	SZX2-CBFL	Brightfield, low-contrast
②	SZX2-CBF	Brightfield, standard
③	SZX2-CBFH	Brightfield, high-contrast
④	SZX2-COBL	Oblique, low-contrast
⑤	SZX2-COB	Oblique, standard
⑥	SZX2-COBH	Oblique, high-contrast
⑦	SZX2-CSH	Shade plate
⑧	SZX2-CDF	Darkfield
⑨	SZX2-CPO	Polarization plate

Designed to Meet Your Application Needs



Reproduce True-to-Life Images with an Olympus Digital Camera

Each microscope digital camera in the SZX2 lineup captures images at high resolution. Olympus stereo microscopes and digital cameras contribute to leading-edge research in biology and medicine.

High-Performance Digital Cameras Provide Accurate and Detailed Image Capture (DP74/DP22)

DP74 Digital Camera

The DP74 color fluorescence camera captures realistic, high-quality images and has features that enable users to make their observations easily. With a wide field of view, operators can capture images of more of their sample, quickly. In applications like histology, the DP74 camera faithfully reproduces colors to render natural images of your specimen. The camera displays a realistic image, so what appears on the monitor looks the same as what you see looking through the microscope's eyepieces. Users can remain comfortable during their work since they can just watch the monitor rather than having to go back and forth between the monitor and eyepieces. The camera is easy to use, so it integrates into any workflow, making it simple to capture publication-quality images.

*DP74 is not for clinical diagnostic use.



DP22 Digital Camera

The DP22 stand-alone camera smoothly displays live images in high-definition while enabling easy observation, focusing, framing, and image archiving. Fine structures are precisely reproduced, and subtle color differences enable users to accurately identify targets on the monitor rather than having to look through the eyepieces. The dedicated control box provides smooth and intuitive operation using a touch screen monitor or a mouse (no PC required).

*DP22 is not for clinical diagnostic use.

Olympus offers wide range of additional microscope digital cameras for variable applications. Please visit www.olympus-lifescience.com for information about our full line of advanced cameras.



Motorized Focus and Zoom Enhance Efficiency (Motorized Focus Unit SZX2-FOA/Motorized Zoom Unit SZX2-ZB16A)

The motorized focus unit has a maximum load capacity of 23 kg (50 lb) and facilitates operation when accessories such as heavy cameras are attached. Adding motorized zoom simplifies both focusing and zooming through use of a hand switch—the good solution for improving examination efficiency. Remote operation is also possible, enabling observation on a monitor.



Vertical Observation

The revolving nosepiece matches the objective lens center to the zoom lens optical path for images with reduced aberration. Image shifting from focus change is eliminated for effective 3D rendering by software.

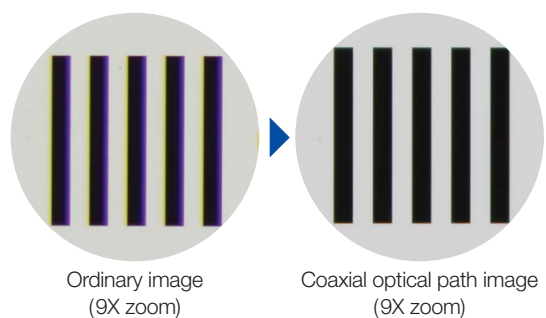
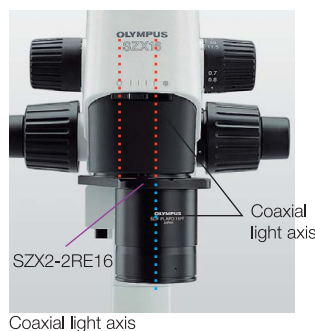

A Wide Array of Components to Observe Various Types of Specimens

Stands and Optional Units

Standard Stand (SZX2-ST)

This standard reflected light illumination stand supports observation conditions where no transmitted light is needed.



Transmitted/Reflected Light Illumination Base

Dual Inter-Lock Light Guide (LG-DI)

This light guide can be positioned as the observer likes for bright, even illumination—especially effective when high-contrast images are required. The spot lens HLL301 can be mounted.



Large Stand (SZX2-STL)

This stand provides a large working space to accommodate large specimens.



Coaxial Illuminator (SZX2-ILLC16/SZX2-ILLC10*)

Used with the dual flexible light guide LG-DF, this illuminator provides bright, even illumination without the need for centering adjustments to the lamp.

* Compatible with the SZX10 only.



Universal Stand Type 2 (SZ2-STU2)

Smooth horizontal movement and rotation enable specimen observation from various angles.



Dual Combination Light Guide (LG-DFI)

The SZX2 light guide can be mounted directly onto the focus drive, keeping the observation position properly illuminated, even when the focus is adjusted or when the specimen is exchanged.



Ring Light Guide (LG-R66)

With its 66 mm diameter mount, this ring light illuminator has been specially developed for stereo microscope compatibility. When mounted with the ring light adapter SZX-LGR66*, it provides bright, uniformly lit images while avoiding glaring reflections or obscuring shadows.

* Compatible with the SZX10 only.



Accessories

Light Beam Splitter (SZX2-LBS)

The adapter enables a digital camera or other imaging unit to be attached on both sides of the SZX2-LBS body. The light path to the camera port can be switched between 100% and 50% light. The 100% light path to the camera port enables dark specimens to be imaged.



Analyzer (SZX2-AN)

The analyzer provides double-refractile image observation of specimens such as sea urchin larvae. The analyzer should be attached to the tip of the objectives.



SZX10 Cost-Effective Performance and Accurate Image Reproduction



A zoom ratio of 10:1 is suitable for operations such as specimen selection or dissection. The SZX10 microscope provides wide viewing and reduces operator fatigue, minimizing mistakes. Choose from a wide range of accessories to suit users' sample needs.

SZX10

Distortion-Free Design Provides Accurate Image Observation

A distortion-free design that has been continually improved by Olympus over the years reduces embossment of the image plane and provides accurate images.

Adjustable Depth of Field with the Built-in AS Zoom Body

Closing the aperture increases the depth of field.

A Wide Array of Accessories Enhance the System for Various Observation and Documentation Methods

The SZX10 microscope's accessories achieve high performance during image capture and monitor observation. This versatile system can be used for a variety of applications.



Extendable Eyepoint Adjuster (SZX2-EEPA)

This unit enables users to continuously adjust the height of the eyepoint between 30 mm to 150 mm depending on the user's eyepoint.



Side-by-Side Discussion Tube (SZX-SDO2)

Ample distance (650 mm) between the main and secondary observer for easy imaging without disturbing the microscope operation. The color of the built-in pointer can be selected to contrast the specimen.



Drawing Attachment (SZX-DA)

This attachment enables users to accurately draw the specimen for scientific study or illustration—a traditional alternative to photomicrography. The accessory can be mounted on either side of the microscope, depending on preference.



Binocular Tubes (SZX-BI30/BI45) Trinocular Tubes (SZX2-TR30/TTR/LTTR)

These tubes enable variable eye points, helping you conduct observations in a natural posture thanks to the tilting head with an incline angle varying between 5° and 45°.



Coaxial Fluorescence Illumination Stand (SZX-RFA)

This fluorescence unit enables observation of fluorescent proteins introduced into living cells.



Discussion Tube (SZX-DO)

Face-to-face, discussion-style intermediate tube enables primary and secondary observers to sit opposite one another during specimen observation. The secondary observer can support the primary observer more effectively in their tasks.

Specifications

SZX16/SZX10 SPECIFICATIONS

Item	Specifications					
	SZX2-ZB16/SZX2-ZB16A			SZX2-ZB10		
Zoom microscope body	Zoom ratio: 16.4:1 (0.7X –11.5X) Magnification indication: 0.7/0.8/1/1.25/1.6/2/2.5/3.2/4/5/6.3/8/10/11.5			Zoom ratio: 10:1 (0.63X –6.3X) Magnification indication: 0.63/0.8/1/1.25/1.6/2/2.5/3.2/4/5/6.3		
	Zoom variable magnification system with parallel optical axis					
	Zoom drive system: Horizontal handle Click-stop for various zoom positions incorporated					
	Motorized zoom body (SZX2-ZB16A), Manual zoom body (SZX2-ZB16, SZX2-ZB10)					
	AS: Built-in					
	Objective mounting: screw mount					
Objective	For SZX2-ZB16/SZX2-ZB16A			For SZX2-ZB10		
	Objectives	NA	W.D. (mm)	Objectives	NA	W.D. (mm)
	SDFPLFL0.3X	0.045	141	DFPL0.5X-4	0.05	171
	SDFPLAPO0.5XPF	0.075	70.5	DFPL0.75X-4	0.075	116
	SDFPLAPO0.8X	0.12	81	DFPLAPO1X-4	0.1	81
	SDFPLAPO1XPF	0.15	60	SZX-ACH1X	0.1	90
	SDFPLAPO1.6XPF	0.24	30	DFPLAPO1.25X	0.125	60
	SDFPLAPO2XPF	0.3	20	SZX-ACH1.25X-2	0.125	68
			DFPL1.5X-4	0.15	45.5	
			DFPL2X-4	0.2	33.5	
Eyepiece	WHN10X-H FN 22	WHSZ15X-H FN 16		WHSZ10X-H FN 22	WHSZ15X-H FN 16	
	WHSZ20X-H FN 12.5	WHSZ30X-H FN 7		WHSZ20X-H FN 12.5	WHSZ30X-H FN 7	
Observation tube	SZX2-TTR/SZX2-TTRPT: Tilting trinocular tube Convergence angle, Tilting angle: 5°–45°, Interpupillary distance adjustment: 52–76 mm, 2-step optical path (selectable) (TTR observation: straight port = 100:0, 50:50) (TTRPT observation: straight port = 100:0, 0:100)					
	SZX2-TR30/SZX2-TR30PT: 30-degree trinocular tube Convergence angle, Tilting angle: 30°, Interpupillary distance adjustment: 52–76 mm, 2-step optical path (selectable) (TR30 observation: straight port = 100:0, 50:50) (TR30PT observation: straight port = 100:0, 0:100)					
	SZX2-LTTR: Ergonomic Long Tilting Trinocular ⁴ Convergence angle, Tilting angle: 5°–45°, Interpupillary distance adjustment: 57–80 mm, 2-step optical path (selectable) (straight port = 100:0, 50:50)					
	—			SZX-BI30: 30° binocular tube Tilting angle: 30° Interpupillary distance adjustment: 51–76 mm		
	—			SZX-BI45: 45° binocular tube Tilting angle: 45° Interpupillary distance adjustment: 52–76 mm		
Focusing assembly	SZX2-FO: Focusing unit / focus: rack and pinion with roller guide (with torque adjustment ring for coarse focusing), optional counter balance, coarse handle stroke: 80 mm, coarse handle stroke per rotation: 21 mm, load capacity: 0–10 kg (0–22 lb)					
	SZX2-FOF: Fine focusing unit / focus: rack and pinion with roller guide (with torque adjustment ring for coarse focusing), coarse and fine coaxial handle, built-in counter balance, coarse handle stroke: 80 mm, coarse handle stroke per rotation: 36.8 mm, fine handle stroke: 80 mm, fine handle stroke per rotation: 0.77 mm, load capacity: 2.7–15 kg (6–33 lb)					
	SZX2-FOFH: Fine focusing unit for heavy loading / focus: rack and pinion with roller guide (with torque adjustment ring for coarse focusing), coarse and fine coaxial handle, built-in gas spring counter balance, coarse handle stroke: 80 mm, coarse handle stroke per rotation: 36.8 mm, fine handle stroke: 80 mm, fine handle stroke per rotation: 0.77 mm, load capacity: 8–25 kg (17.6–55 lb)					
	SZX2-FOA: Motorized focus unit / focus: rack and pinion with roller guide, focusing stroke: 78 mm, motorized focusing speed coarse: 2.7 mm/s, fine: 0.27 mm/s load capacity: 0–23 kg (0–50 lb)					
Extendable Eyepoint adjuster	SZX2-EEPA: Height adjustment range: 30–150 mm (with a scale attached)					
Stand	SZX2-ST: Standard stand / Pillar height: 270 mm, base dimension (W × D × H): 284 mm × 335 mm × 31 mm (11.2 in. × 13.2 in. × 1.2 in.), stage clips are mountable, with stage adapter fixing screw holes					
	SZX2-STL: Large stand / Pillar height: 400 mm, base dimension (W × D × H): 400 mm × 350 mm × 28 mm (15.7 in. × 13.8 in. × 1.1 in.), stage clips are mountable, with stage adapter fixing screw holes					

⁴ SZX2-LTTR: intermediate magnification is 1.25X

TRANSMITTED ILLUMINATION BASE SPECIFICATIONS

Item	Specifications	
	SZX2-ILLTQ	SZX2-ILLTS
Light source	White LED (Average service life: about 60,000 hours by rated use.)	
Light intensity adjustment	Continuously variable system	
Effective illuminated area	Brightfield (Low contrast): φ63 mm, Brightfield (Standard/High)/Darkfield/Oblique/Polarized: φ35 mm	
Option filter	φ45mm filter (for SZX2-CBF/SZX2-CBFH), 75 mm × 75 mm (3 in. × 3 in.) sheet filter for photo	
Illumination mode	Selection by changing cartridges (Cartridges are optional.), Brightfield illumination (Low/Standard/High contrast), Darkfield illumination, Oblique illumination (Low/Standard/High contrast), Polarized illumination	
Contrast selection	Low/Standard/High (Brightfield/Oblique)	
Turret position number for illumination base	4	1
The height of stage (from desk surface)	41.5 mm (1.6 in.)	
Pillar height (from stage surface)	268.5 mm (10.6 in.)	
Weight	Approx. 4.1 kg (9.0 lb)	Approx. 3.8 kg (8.4 lb)
Power source	AC100–240 V, 50–60 Hz (AC adapter)	

REFLECTED LIGHT ILLUMINATORS SPECIFICATIONS

Type	Ring light guide LG-R66	Dual ring light guide LG-DFI/DI	Coaxial illuminator SZX2-ILLC16/10
Features	Bright, uniformly lit images without glaring reflections or obscuring shadows	Flexible illumination for any angle and position	Bright, high-contrast coaxial illumination. Effective for observing glossy sample, such as insects, plants, new materials, etc.
Illumination specifications	Minimum W.D.: 30 mm Mount diameter: 66 mm Flexible part: 1000 mm Attachment adapter*: SZX-LGR66 *No adapter required for SZX16-LGR66 *Unable to attach to SDFPLAPO2XPFC/SDFPLAPO1.6XPF	LG-DFI: Flexible part 1000 mm Inter-lock part 500 mm LG-DI: Inter-lock part 500 mm	Magnification factor: 1.5X Light guide: LG-DF Flexible part 1000 mm 1/4 wavelength retardation plate included
Light source specifications	Type: LG-LSLED (LED light source for light guide) Functions: Continuous Electronic Dimming (0~100%), Filter slider, Silent fan, Power Consumption: max. 37 W Operating Voltage, Frequency: AC100~240 V, 50~60 Hz (AC adapter) Dimension (W × D × H): 231 mm × 114 mm × 137 mm (9.1 in. × 4.5 in. × 5.4 in.) Weight: Approx. 2.7 kg (6.0 lb) including AC adapter		
Options	—	HILL301: Spot lens	—

REFLECTED LIGHT FLUORESCENCE ILLUMINATOR

Type	Reflected light fluorescence illuminator/Motorized focusing unit SZX2-RFA16A	Reflected light fluorescence illuminator/Fine focusing unit SZX2-RFA16	Reflected light fluorescence illuminator SZX-RFA
Illumination method	Near-vertical reflected light fluorescence illumination that corresponds to the microscope zoom function; zooming on the illuminator is independent of the microscope body's zoom function.		Coaxial illumination
Filter turret	Five-position turret Maximum 5 sets of excitation/emission filter sliders are attachable. Comes with shutter that prevents flash-light caused by switching.		Four-step slide switch Maximum 3 mirror units are attachable. Comes with shutter that prevents flash-light caused by switching.
Filter holder slider	Three-step switch by shutter and two holes. ND filter can be attached at the holes.		
Filter slider	One excitation balancer can be attached.		—
Focusing assembly	Built-in Motorized focus unit / focus: rack and pinion with roller guide, focusing stroke: 67 mm, motorized focusing speed coarse: 2.7 mm/s, fine: 0.03 mm/s load capacity: 0~19.3 kg (0~42.5 lb)	Built-in Fine focusing unit / focus: rack and pinion with roller guide (with torque adjustment ring for coarse focusing), coarse and fine coaxial handle, built-in counter balance, coarse handle stroke: 69 mm, coarse handle stroke per rotation: 36.8 mm, fine handle stroke: 69 mm, fine handle stroke per rotation: 0.77 mm, load capacity: 2.7~15 kg (6~33 lb)	—
Light source	100 W Hg lamp housing or 130 W Hg light guide illumination		

TOTAL MAGNIFICATIONS AND ACTUAL FIELD DIAMETERS OF SZX2-ZB16/SZX2-ZB16A*1

Objective	Eyepiece							
	WHN10X-H		WHSZ15X-H		WHSZ20X-H		WHSZ30X-H	
	total mag.	field diameter (mm)	total mag.	field diameter (mm)	total mag.	field diameter (mm)	total mag.	field diameter (mm)
SDFPLFL0.3X	2.1X~34.5X	ø104.8~ø6.4	3.2X~51.8X	ø76.2~ø4.6	4.2X~69X	ø59.5~ø3.6	6.3X~103.5X	ø33.3~ø2.0
SDFPLFL0.5XPF	3.5X~57.5X	ø62.9~ø3.8	5.3X~86.3X	ø45.7~ø2.8	7X~115X	ø35.7~ø2.2	10.5X~172.5X	ø20.0~ø1.2
SDFPLAPO0.8X	5.6X~92X	ø39.3~ø2.4	8.4X~138X	ø28.6~ø1.7	11.2X~184X	ø22.3~ø1.4	16.8X~276X	ø12.5~ø0.8
SDFPLAPO1XPF	7X~115X	ø31.4~ø1.9	10.5X~172.5X	ø22.9~ø1.4	14X~230X	ø17.9~ø1.1	21X~345X	ø10.0~ø0.6
SDFPLAPO1.6XPF	11.2X~184X	ø19.6~ø1.2*2	16.8X~276X	ø14.3~ø0.9	22.4X~368X	ø11.2~ø0.7	33.6X~552X	ø6.3~ø0.4
SDFPLAPO2XPFC	14X~230X	ø15.7~ø1*2	21X~345X	ø11.4~ø0.7*2	28X~460X	ø8.9~ø0.5	42X~690X	ø5.0~ø0.3

*1 SZX2-LTTR: intermediate magnification is 1.25X *2 Some vignetting may occur from optical characteristics. This occurs in observations at low magnification.

TOTAL MAGNIFICATIONS AND ACTUAL FIELD DIAMETERS OF SZX2-ZB10*3

Objective	Eyepiece							
	WHN10X-H		WHSZ15X-H		WHSZ20X-H		WHSZ30X-H	
	total mag.	field diameter (mm)	total mag.	field diameter (mm)	total mag.	field diameter (mm)	total mag.	field diameter (mm)
DFPL0.5X-4	3.2X~31.5X	ø69.8~ø7.0	4.7X~47.3X	ø50.8~ø5.1	6.3X~63X	ø39.7~ø4	9.5X~94.5X	ø22.2~ø2.2
DFPL0.75X-4	4.7X~47.3X	ø46.6~ø4.7	7.1X~70.9X	ø33.9~ø3.4	9.4X~94.5X	ø26.5~ø2.6	14.2X~141.8X	ø14.8~ø1.5
DFPLAPO1X-4 SZX-ACH1X	6.3X~63X	ø34.9~ø3.5	9.5X~94.5X	ø25.4~ø2.5	12.6X~126X	ø19.8~ø2	18.9X~189X	ø11.1~ø1.1
DFPLAPO1.25X SZX-ACH1.25X-2	7.9X~78.9X	ø27.9~ø2.8	11.8X~118.1X	ø20.3~ø2	15.8X~157.5X	ø15.9~ø1.6	23.6X~236.3X	ø8.9~ø0.9
DFPL1.5X-4	9.5X~94.5X	ø23.3~ø2.3	14.2X~141.8X	ø16.9~ø1.7	18.9X~189X	ø13.2~ø1.3	28.4X~283.5X	ø7.4~ø0.7
DFPL2X-4	12.6X~126X	ø17.5~ø1.7	18.9X~189X	ø12.7~ø1.3	25.2X~252X	ø9.9~ø1	37.8X~378X	ø5.6~ø0.6

*3 SZX2-LTTR: intermediate magnification is 1.25X

System Diagram

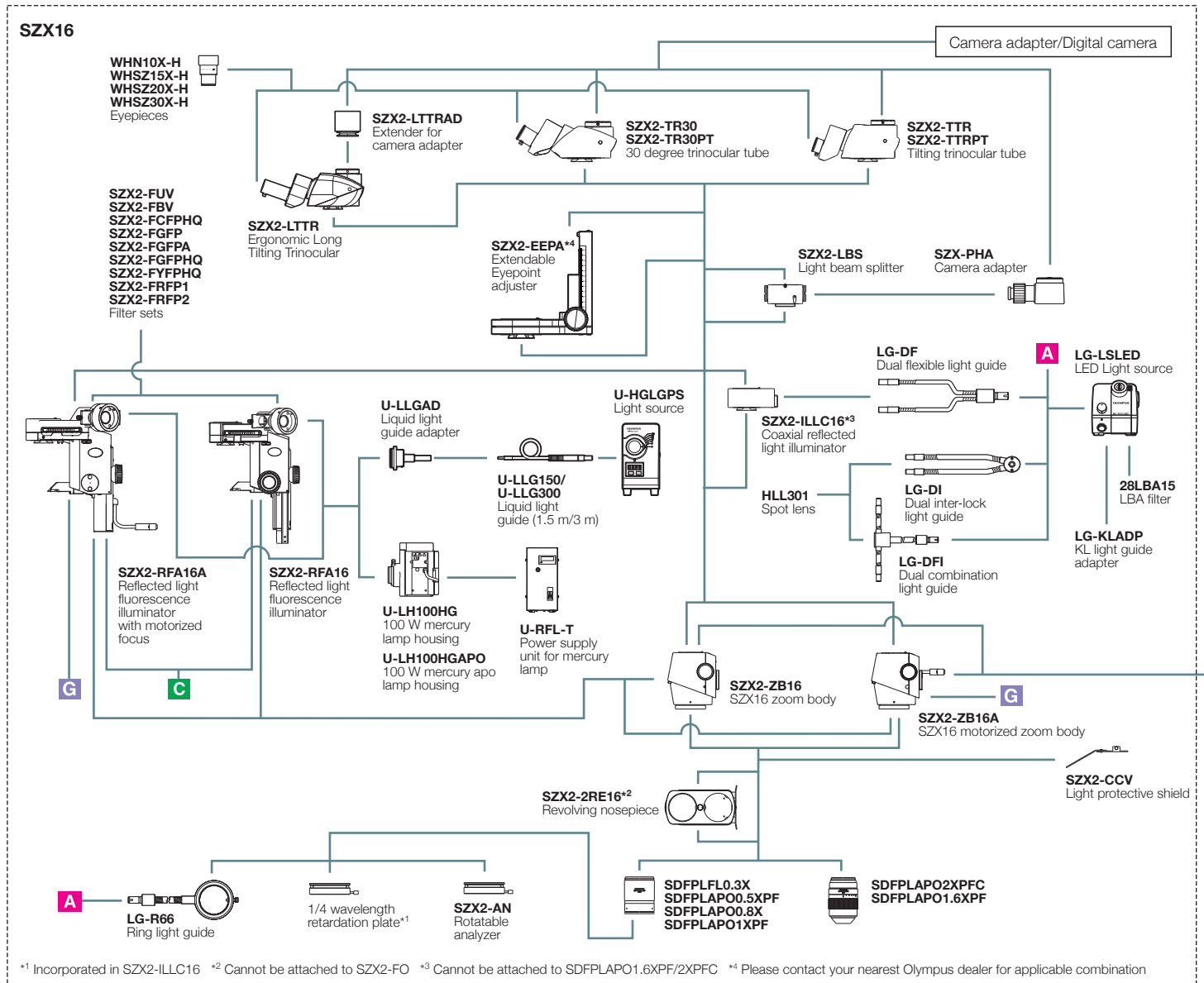

*1 Incorporated in SZX2-ILLC16 *2 Cannot be attached to SZX2-FO *3 Cannot be attached to SDFPLAPO1.6XPF/2XPFC *4 Please contact your nearest Olympus dealer for applicable combination

Accessories

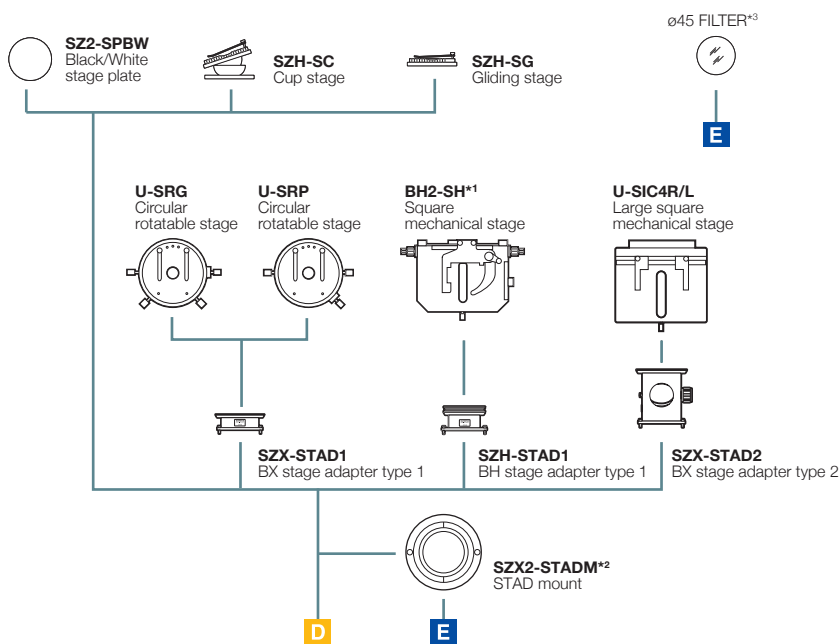

*1 Not available in some areas *2 SZX2-STADM cannot be combined with SZ2-SPBW, SZX-STAD2
*3 ø45 FILTER can be combined with only SZX2-CBF and SZX2-CBFH

Focusing units

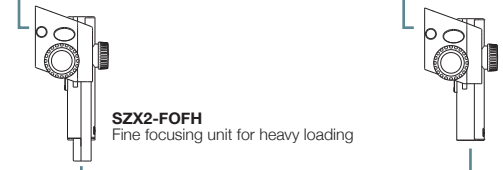

Illuminators

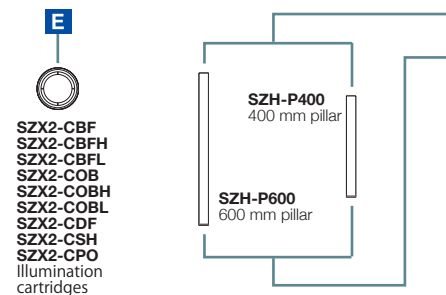

SZX10

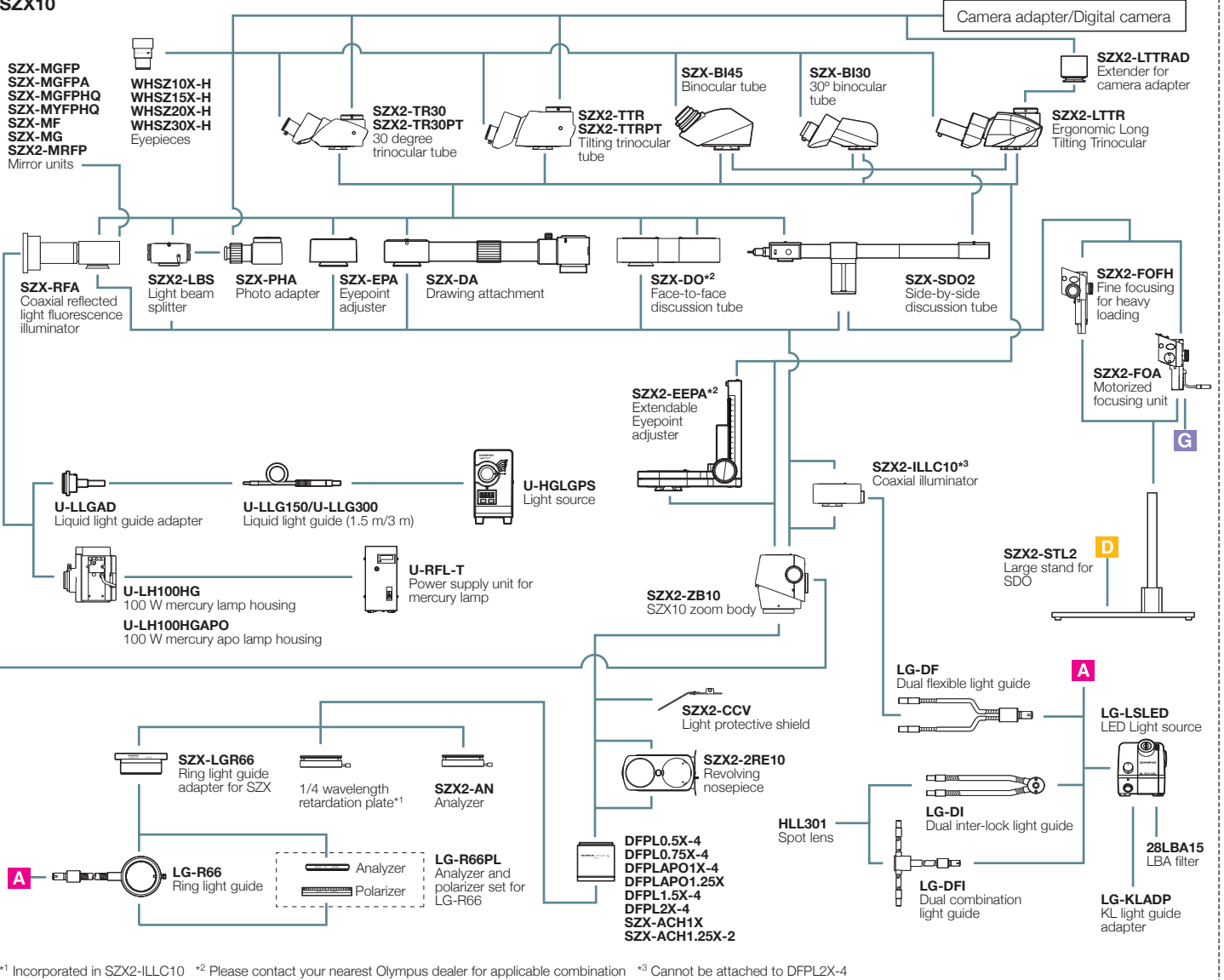

*1 Incorporated in SZX2-ILLC10 *2 Please contact your nearest Olympus dealer for applicable combination *3 Cannot be attached to DFPL2X-4

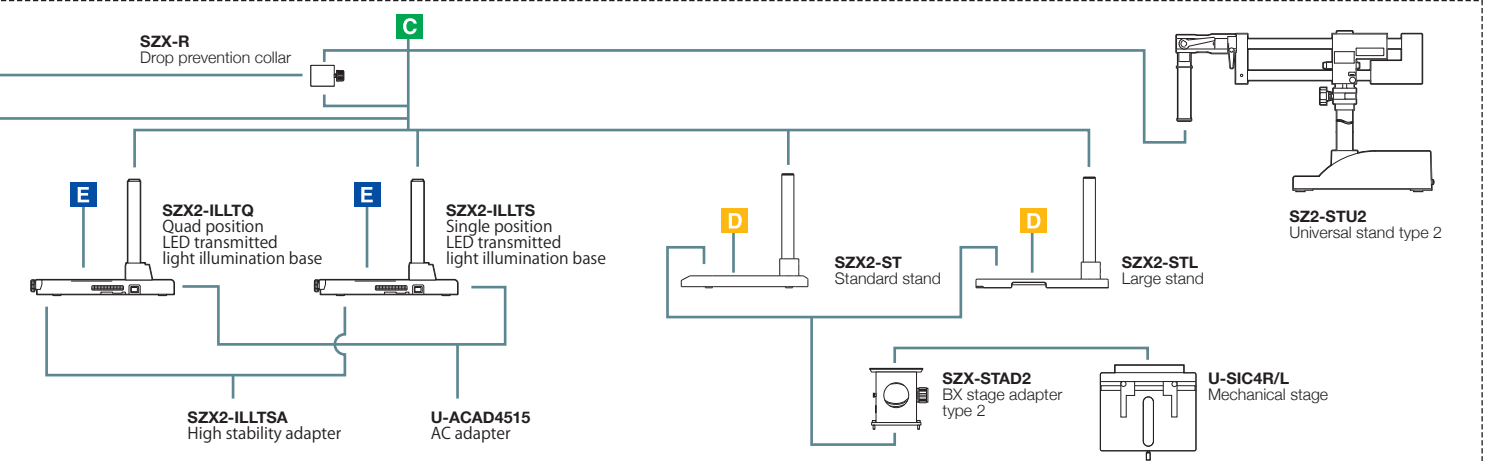
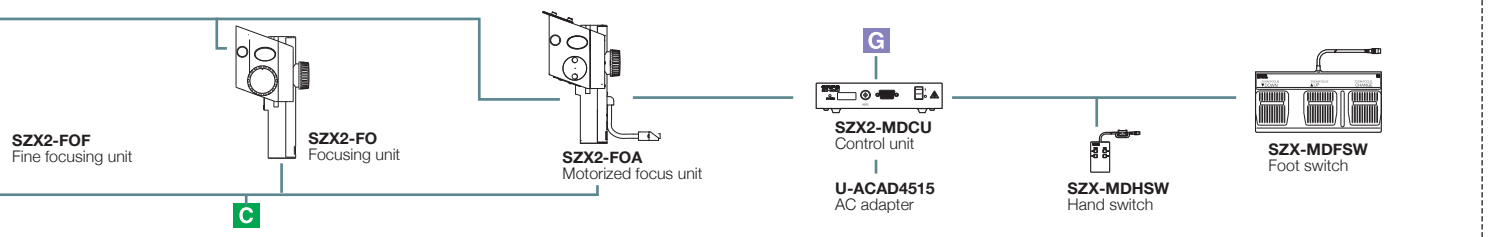

Images are courtesy of the following institutions

RIKEN Brain Science Institute,
Laboratory for Developmental Gene Regulation
(page 3, lower left; pages 7, top left and lower right; page 8).

RIKEN Center for Developmental Biology,
Laboratory for Cell Asymmetry, Dr. Ayano Kawaguchi
(page 3, lower right).

Graduate School of Medicine and Faculty of Medicine,
the University of Tokyo, Department of Cell Biology and Anatomy, Dr. Yasushi Okada
(page 3, middle right; page 7, top right).

National Institute of Advanced Industrial Science and Technology,
Research Institute for Cell Engineering, Neuronics Research Group
(page 1, right).

Drosophila melanogaster
Institute of Molecular and Cellular Biosciences, University of Tokyo, Kei Ito, Ph.D.
(page 13 ; page 14, top right)

National Institute for Basic Biology, Spectrography and Bioimaging Facility, Joe Sakamoto Ph.D., Yasuhiro Kamei Ph.D.
(cover page, top right; page 1, left; page 5, lower left; page 11, top left; page 11, lower right)

- **OLYMPUS CORPORATION is ISO14001 certified.**
- **OLYMPUS CORPORATION is ISO9001 certified.**
- **OLYMPUS CORPORATION is ISO13485 certified.**
- **Illumination devices for microscope have suggested lifetimes. Periodic inspections are required. Please visit our website for details.**

- All company and product names are registered trademarks and/or trademarks of their respective owners.
- Images on the PC monitors are simulated.
- Specifications and appearances are subject to change without any notice or obligation on the part of the manufacturer.

www.olympus-lifescience.com

OLYMPUS[®]

OLYMPUS CORPORATION
Shinjuku Monolith, 2-3-1 Nishi-Shinjuku, Shinjuku-ku, Tokyo 163-0914, Japan

Printed in Japan M1597E-052019